

I Sing to God

Lesson Objectives

- The children will worship God with song, music and dance.
- The children will say "David" when asked who sang, played music and danced in worship to God.
- The children will learn that singing and dancing is worshipping God.

Bible Story Text

Psalms 101:1; 108:1-3; 138:1

Bible Truth

Sing to the Lord.
(Psalm 96:1)

Lesson Plan

Greeting and Registration

Preclass Activity: Preclass Centers

Welcome and Singing

Centers:

Bible Story: David Worships God

Life Application: Sing and Dance for God

Craft: Lord of the Dance

NOTE: Be sure to allow sufficient time for a snack.



I Sing to God

Preclass Centers

As the children arrive, guide them to a preclass center. Have no more than six children at each center.

Materials

Use the materials previously selected for this unit's preclass centers.

Preparation

1. Be sure to check the condition of the materials selected for this unit's preclass centers prior to set up. Replace any broken toys, or puzzles with missing pieces as necessary.
2. Set up the centers before the children come into the classroom.
3. Assign a teacher to each center and have the teachers stay in those centers until the singing begins.

Instructions

Guide the play in each center reinforcing the unit theme.

Teacher Tips

- **IMPORTANT:** Do not allow any small toys in the classroom. First check all toys for size. You can obtain a "safety cylinder" from a pediatrician. Any object that can fit into the cylinder is too small and could cause a child to choke.
- Be involved in the group play and offer guidance as needed.
- Wear comfortable clothes suitable for sitting on the floor.
- Smile! Be childlike in heart and alert in mind.

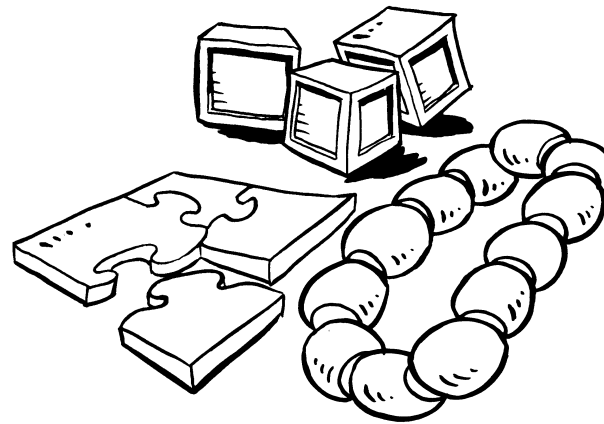

I Sing to God

David Worships God

The children will learn how David worshipped God with song, music and dance.

Bible Story Text

Psalms 101:1, 108:1-3, 138:1

Materials

For the teacher:

- Bible
- diorama from the Unit 15 Lesson 1, Bible Story
- David figure from the Unit 15 Lesson 1, Bible Story
- cassette tape player
- cassette tape of spiritual music with a beat

Preparation

1. Insert the David figure into the slit as shown in Figure A.
2. Have the tape set to an appropriate song and ready to play.

Singing and Dancing

Does anyone here like to sing and dance? Today we are going to hear about a man from the Bible who loved to sing and dance for God. His name was David. Let's all say that together: "David."

Open the Bible. *The Bible says that David was a young man who really loved God. He spent lots of time outside taking care of his father's sheep. Show the children the box without the David figure. Point to the sheep inside the shoebox. What sound does a sheep make? Make sheep sounds with the children. Add the David figure, inserting the craft stick through the slit in the box.*

David liked to think about God while he took care of the sheep. When he looked at the sky and saw all the beautiful clouds that God made, and when he saw the trees and the beautiful hills of grass, he would think about how incredible God is!

Do you know what David did to show how much he loved God? He sang songs to God, and he danced for God! That is called worshipping God. Let's say that together: "worshipping." Do you think people who are worshipping God are happy or sad? Yes, happy! Do you think God wants us to be happy or sad? Yes, he wants us to be happy! Well, when David saw all that God had made and thought about how much God loved him, it made him so happy that he danced and sang to God.

Turn on the music and move the David figure as if he were dancing. *Do you feel like dancing for God? I think that God would love for us to dance and sing to him today! Let's stand up and dance with David.*

NOTE: Save the diorama and David figure for the Unit 15 Lesson 5, Bible Story.

Conclusion

Let's talk about what we learned today. Who was David? He was a man in the Bible who took care of sheep. Did David love God? Yes! How did David show that he loved God? He showed it by dancing and singing to God! Do you know you can dance and sing all by yourself, like David did? You can also dance and sing with other people, like we danced together in class today? That is called worshipping God, and you can worship God all by yourself or with other people. The next time you hear some fun music, you can sing and dance for God, just like David!

Teacher Tips

- Have the children dance in one spot, so they don't wander around the room, disrupting other groups.

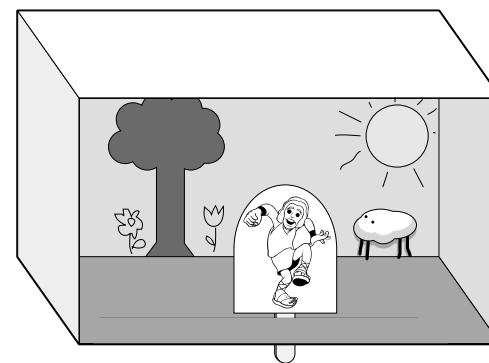

I Sing to God

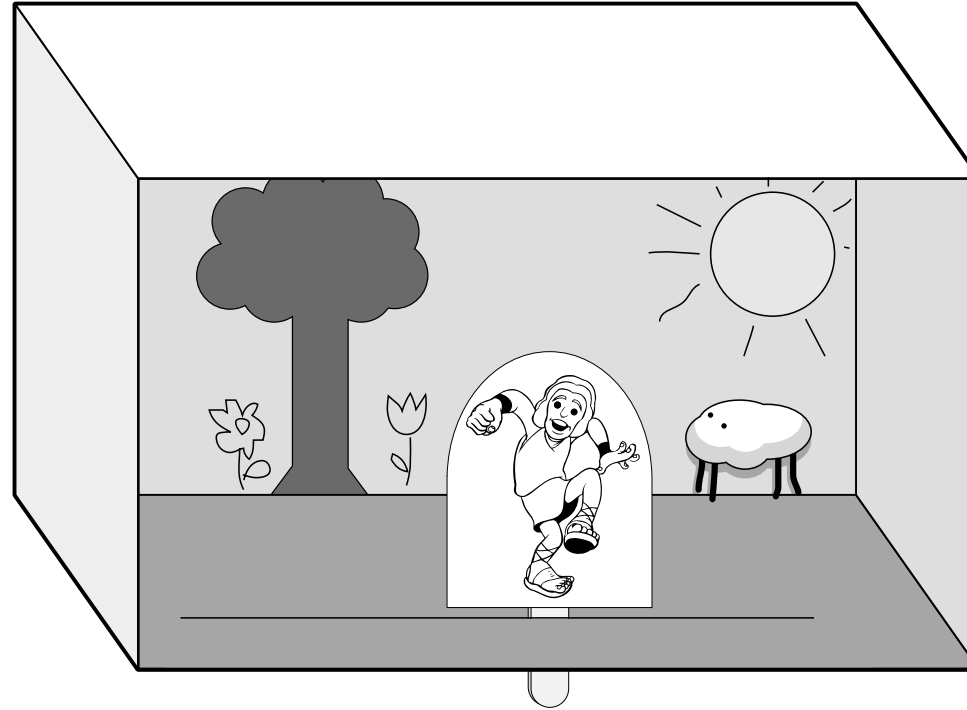

Figure A



I Sing to God

Sing and Dance for God

The children will sing songs and dance for God.

Bible Truth

Sing to the Lord.
(Psalm 96:1)

Materials

For the teacher:

- Bible
- praise sticks from the Unit 15 Lesson 1, Life Application
- cassette tape player
- children's tape of spiritual songs

Preparation

1. Learn a simple song from the church songbook that praises God. Practice the song until you can sing it confidently and with enthusiasm.
2. Choose two upbeat songs from the children's tape of spiritual songs.
3. Familiarize yourself with the activity.

Instructions

1. Open the Bible. *The Bible says, "Sing to the Lord." In the Bible story today you are learning that David sang to the Lord while he watched his father's sheep. Can everyone say David? The Bible says that David sang and danced to the Lord. That's also called worshipping God. That is what we are going to do today! We are going to sing and dance for God! We are going to worship God.*
2. Sing a simple song of praise with the children. Sing it a few times.
3. Give each of the children a praise stick and show them how to carefully move and twirl it to the music.
4. Sing and dance with the children using the praise sticks.
5. Collect the praise sticks from the children.

Bible Truth Activity

Who can tell me what we were just doing? Yes, we were singing and dancing.

The Bible says, "Sing to the Lord." Let's say that together: "Sing to the Lord." Who likes to sing to the Lord? Joseph, do you like to sing to the Lord? God loves to hear us sing. He loves when we are happy!

Conclusion

Let's talk to God and thank him.

Dear God, thank you for giving us our legs so that we can dance for you. Thank you for giving us our voices so that we can sing to you. Help us to be like David and sing to you every day! In Jesus' name we pray. Amen.

Who are you going to tell about Bible class today? What are you going to tell them?



Sing to the Lord.



Craft

I Sing to God Lord of the Dance

This craft will remind the children to dance to God as David did.

Materials

For each child:

- 1 toilet paper tube
- paper bag (optional)

For the teacher:

- water-soluble tempera paint, bright color
- paint brush
- scissors
- glue stick
- tape
- crepe paper in bright colors
- black marker

Preparation

1. Paint the outside of each toilet paper tube for each child.
2. After the tubes have dried, write on each tube, "Sing and dance to the Lord."
3. For each child, cut six 24" strips of crepe paper. NOTE: Try to mix at least two colors for each child.
4. Make a model of the craft following the instructions.

Instructions

1. Show the children your model. Wave the craft in the air, showing how it moves. Remind the children that David sang and danced for God. Explain that they can also sing and dance to God. *Today you are going to make a craft to help you dance and worship God.*
2. Give each child a painted toilet paper tube and their six strips of crepe paper.
3. Help each child to tape the strips to the end of the tube. See Figure A.
4. After the strips are taped on, place another long piece of tape around the toilet paper tube to hold the strips in place. See Figure B.

Conclusion

Have the children stand up. Using a song from the Unit 15 Song Sheet, sing and dance together while waving your crafts.

Remind the children that David sang and danced in worship to God because he loved him. God wants us to sing and dance to him because we love him and worship him, too.

Teacher Tips

- You can use ribbon instead of crepe paper, but you will have to staple the ribbon to the toilet paper tube. Be sure to tape over the staples to smooth over any rough edges.
- If it is a rainy day, bring a bag in which each child can place their craft. If it gets wet, crepe paper color will run and stain anything it touches.

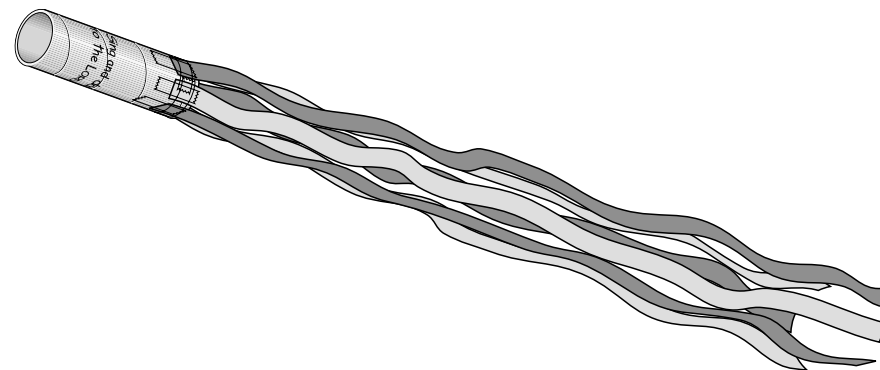

craft

I Sing to God

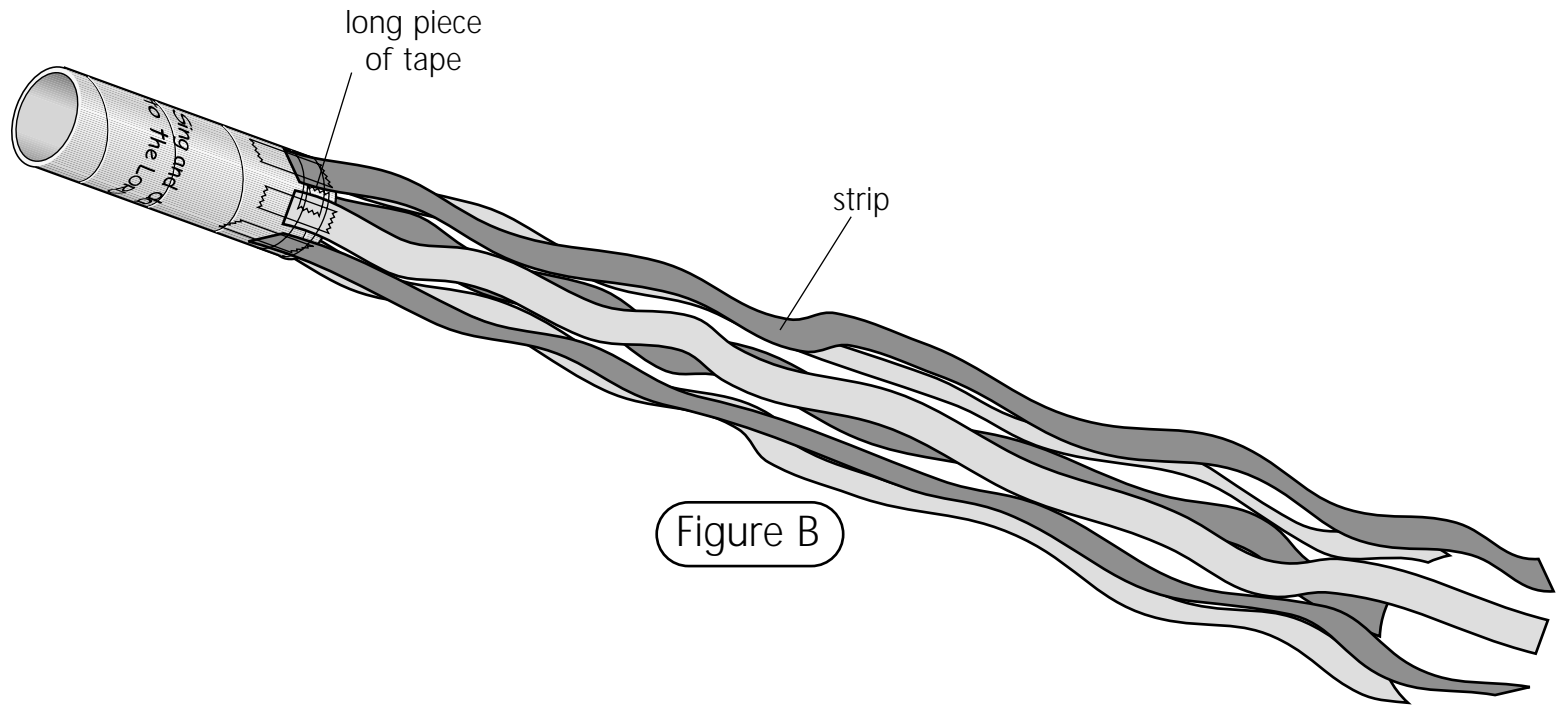
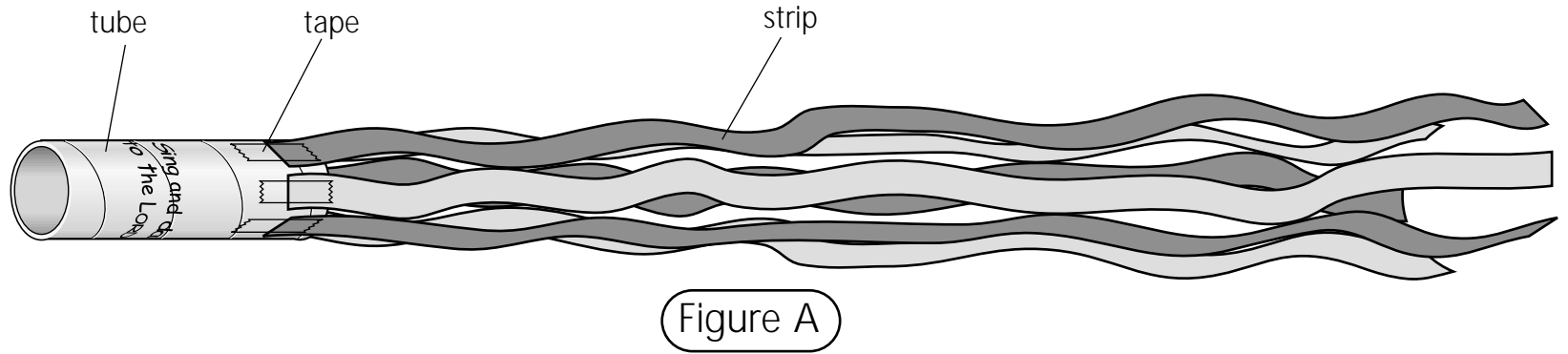



Lesson Objectives

- The children will worship God with song, music and dance.
- The children will say "David" when asked who sang, played music and danced in worship to God.
- The children will learn that singing and dancing is worshipping God.

Bible Story Text

Psalms 101:1, 108:1-3, 138:1

Bible Truth

Sing to the Lord.
(Psalm 96:1)

Preclass Centers

As the children arrive, guide them to a pre-class center. Have no more than six children at each center.

Materials

Use the materials previously selected for this unit's preclass centers.

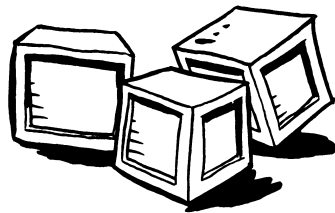

Preparation

1. Be sure to check the condition of the materials selected for this unit's preclass centers prior to set up. Replace any broken toys, or puzzles with missing pieces as necessary.
2. Set up the centers before the children come into the classroom.
3. Assign a teacher to each center and have the teachers stay in those centers until the singing begins.

Instructions

Guide the play in each center reinforcing the unit theme.

I Sing to God

Worshipping God Lesson 2

Lesson Plan

Greeting and Registration

Preclass Activity: Preclass Centers

Welcome and Singing

Centers:

Life Application: Make a Joyful Noise

Bible Story: David Worships God

Craft: Music Maker

NOTE: Be sure to allow sufficient time for a snack.

Teacher Tips

- **IMPORTANT:** Do not allow any small toys in the classroom. First check all toys for size. You can obtain a "safety cylinder" from a pediatrician. Any object that can fit into the cylinder is too small and could cause a child to choke.
- Be involved in the group play and offer guidance as needed.
- Wear comfortable clothes suitable for sitting on the floor.
- Smile! Be childlike in heart and alert in mind.

Make a Joyful Noise

The children will make a joyful noise playing instruments and singing praises to God.

Materials

For each child:

- 1 instrument (real, toy, or homemade)

For the teacher:

- Bible
- cassette tape player
- children's Bible song cassette tape

Preparation

Choose two songs from the tape that are upbeat and cue the tape so that it is ready to play.

Instructions

1. Open the Bible. *The Bible says, "Sing to the Lord." Do you remember who sang to the Lord while he watched his father's sheep? Yes, David! Can everyone say "David"? The Bible says David sang to the Lord. The Bible also says, "Make a joyful noise to the Lord." Sometimes we praise God with singing, sometimes with dancing, sometimes by making a joyful noise!*
2. *First, we are going to make a joyful noise with our voices. Let's all make a joyful noise! Can you say "Amen"?*
3. Sing "If You're Happy and You Know It" from the Unit 15 Song Sheet.
4. *David sang to God because he loved God and wanted to show him that he loved him. When David sang to God, sometimes he would play an instrument. We are going to play these instruments today, and make a joyful noise to God.*
5. Give each child an instrument.
6. Play the tape and have the children play their instruments with the song.
7. Repeat as time allows, trading instruments between each song.

I Sing to God

Bible Truth Activity

Today we sang and played instruments for God. Do you remember what song we just sang? The Bible says, "Sing to the Lord." Let's say that together: "Sing to the Lord." Who likes to sing to the Lord? When we sing to the Lord, we are praising God and showing God how happy we are.

Conclusion

Let's thank God for music. Dear God, thank you for giving us instruments, so we can make a joyful noise to you. Thank you for giving us our voices, so we can sing to you. Help us to be like David and sing to you every day! Help us to praise you and worship you every day. In Jesus' name we pray. Amen.

Who are you going to tell about Bible class today? What are you going to tell them?

Teacher Tips

- Here are some ideas for making instruments: a drum from a round container with a plastic cover; a shaker from dried beans or uncooked macaroni inside two paper plates stapled together; a horn from a rolled piece of paper; bells tied together with ribbon or yarn; a guitar from a shoe box with rubber bands strung across the opening.
- If you use instruments that a child will put their mouth on, be sure to clean it with soap and water before another child uses it.
- IMPORTANT: Check any small pieces in making the instruments. Check with the lead teacher to obtain a "safety cylinder" from a pediatrician. Any object that can fit into the cylinder is too small and could cause a child to choke.



David Worships God

The children will learn that God likes us to worship him with song, music and dance, just as David did.

Bible Story Text

Psalms 101:1, 108:1-3, 138:1

Materials

For the teacher:

- Bible
- diorama from the Unit 15 Lesson 1, Bible Story
- David figure from the Unit 15 Lesson 1, Bible Story
- cassette tape player
- cassette tape of spiritual music with a beat

Preparation

1. Insert the David figure into the slit as shown in Figure A.
2. Have the tape set to an appropriate song and ready to play.

Singing and Dancing

Does anyone here like to sing and dance? Today we are going to hear about a man from the Bible who loved to sing and dance for God. His name was David. Let's all say that together: "David."

Open the Bible. *The Bible says that David was a young man who really loved God. He spent lots of time outside taking care of his father's sheep. Show the children the box without the David figure. Point to the sheep inside the shoebox. What sound does a sheep make? Make sheep sounds with the children. Add the David figure, inserting the craft stick through the slit in the box.*

David liked to think about God while he took care of the sheep. When he looked at the sky and saw all the beautiful clouds that God made, and when he saw the trees and the beautiful hills of grass, he would think about how incredible God is!

Do you know what David did to show how much he loved God? He sang songs to God, and he danced for God! That is called worshipping God. Let's say that together: "worshipping." Do you think people who are worshipping God are happy or sad? Yes, happy! Do you think God wants us to be happy or sad? Yes, he wants us to be happy! Well, when David saw all that God had made and thought about how much God loved him, it made him so happy that he danced and sang to God.

I Sing to God

Worshipping God Lesson 2

Turn on the music and move the David figure as if he were dancing. *Do you feel like dancing for God? I think that God would love for us to dance and sing to him today! Let's stand up and dance with David.*

NOTE: Save the diorama and David figure for the Unit 15 Lesson 5, Bible Story.

Conclusion

Let's talk about what we learned today. Who was David? He was a man in the Bible who took care of sheep. Did David love God? Yes! How did David show that he loved God? He showed it by dancing and singing to God! Do you know you can dance and sing all by yourself, like David did? You can also dance and sing with other people, like we danced together in class today? That is called worshipping God, and you can worship God all by yourself or with other people. The next time you hear some fun music, you can sing and dance for God, just like David!

Teacher Tips

- Have the children dance in one spot, so they don't wander around the room, disrupting other groups.

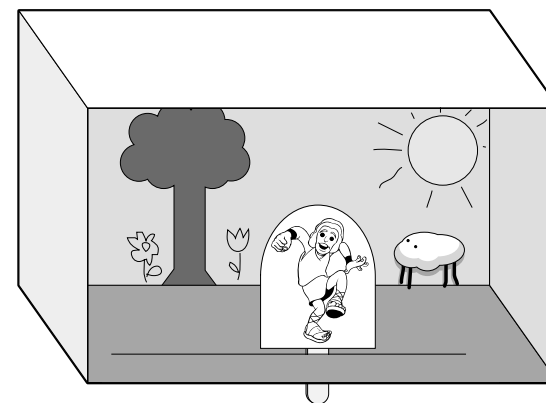

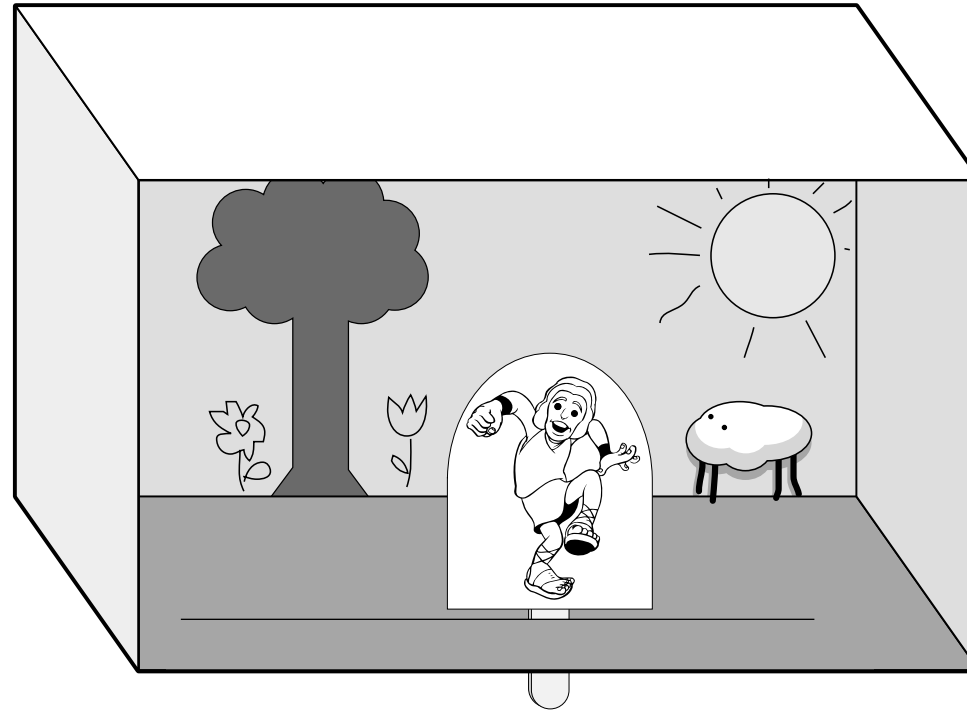

Figure A



Music Maker

The children will make musical instruments so they can make music to God.

Bible Truth

Sing to the Lord.
(Psalm 96:1)

Materials

For each child:

- 1 toilet paper tube
- glue stick

For the teacher:

- wrapping paper
- scissors
- yarn or ribbon
- 1 bag of beans

Reproducible Pages:

- Page A, 1 copy for every 5 children

Preparation

1. Cut out the text boxes from the copies of Reproducible Page A.
2. Cut an 8" x 6" piece of wrapping paper for each child.
3. Cut two 8" pieces of yarn for each child.
4. Make a model of the craft following the instructions.

Instructions

1. Show the children your model of the craft. Read the text box to them: *"Sing to the Lord." The Bible says that we should sing to the Lord and that we should dance and make a joyful noise. Do you think that you could use this instrument to make a joyful noise to God?* Pass the instrument around, letting each child "play" it.
2. Give each child a toilet paper tube, and then have them cover it with glue using the glue stick.

I Sing to God

Worshipping God Lesson 2

3. Help each child to roll their tube onto the piece of wrapping paper, as shown in Figure A.
4. Help the children to finish their instruments as follows:
 - A. Help each child to tie one end of the wrapping paper closed with a piece of yarn. See Figure B.
 - B. Give each child a handful of beans to place inside the open end of the tube.
 - C. Help each child to tie the remaining end closed with the remaining piece of yarn.
 - D. Help each child to glue a text box to their instruments.

Conclusion

Have the children make music with their music makers and dance to the Lord.

Teacher Tips

- Have stickers for the children to decorate the music makers.
- Have the children make their own wrapping paper during the Preclass Activity. They can use white paper or brown paper bags with paint or markers.



C
r
a
f
t

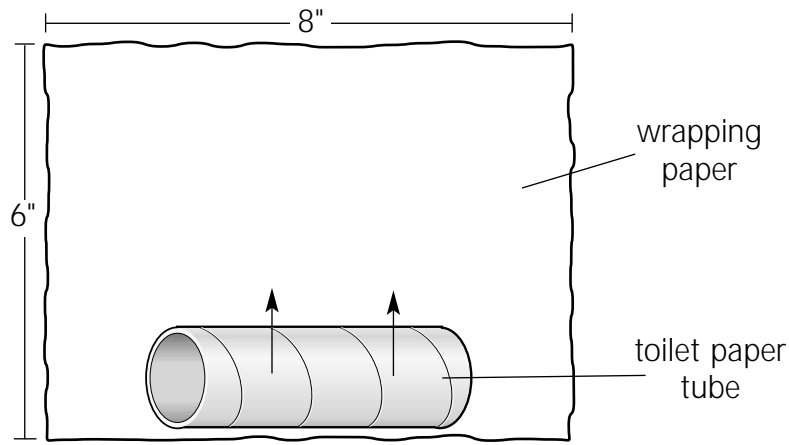

Figure A

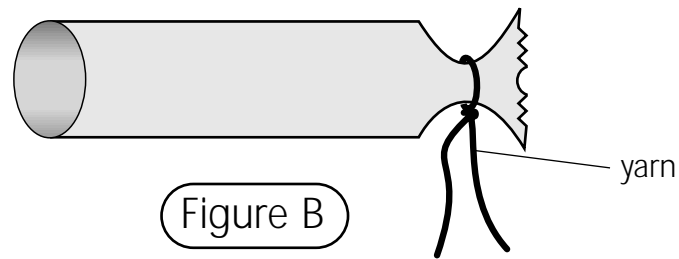

Figure B



Finished Craft





R
e
p
r
o
d
u
c
i
b
l
e

<p>Sing to the LORD. Psalm 96:1</p>
<p>Sing to the LORD. Psalm 96:1</p>
<p>Sing to the LORD. Psalm 96:1</p>
<p>Sing to the LORD. Psalm 96:1</p>
<p>Sing to the LORD. Psalm 96:1</p>

text boxes

