

Jesus Is Thankful

Thankfulness
Lesson 2

Lesson Objectives

- When asked who healed the ten sick men, the children will answer "Jesus."
- The children will thank an adult for taking care of them.
- The children will thank God for taking care of them.

Bible Story Text

Luke 17:11-19

Bible Truth

Give thanks to God.
(Psalm 136:26)

Lesson Plan

Greeting and Registration

Preclass Activity: Preclass Centers

Welcome and Singing

Centers:

Bible Story: Ten Sick Men

Life Application: Thank You

Craft: One Came Back

NOTE: Be sure to allow sufficient time for a snack.



Jesus Is Thankful

Preclass Centers

As the children arrive, guide them to a preclass center. Have no more than six children at each center.

Materials

Use the materials previously selected for this unit's preclass centers.

Preparation

1. Be sure to check the condition of the materials selected for this unit's preclass centers prior to set up. Replace any broken toys, or puzzles with missing pieces as necessary.
2. Set up the centers before the children come into the classroom.
3. Assign a teacher to each center and have the teachers stay in those centers until the singing begins.

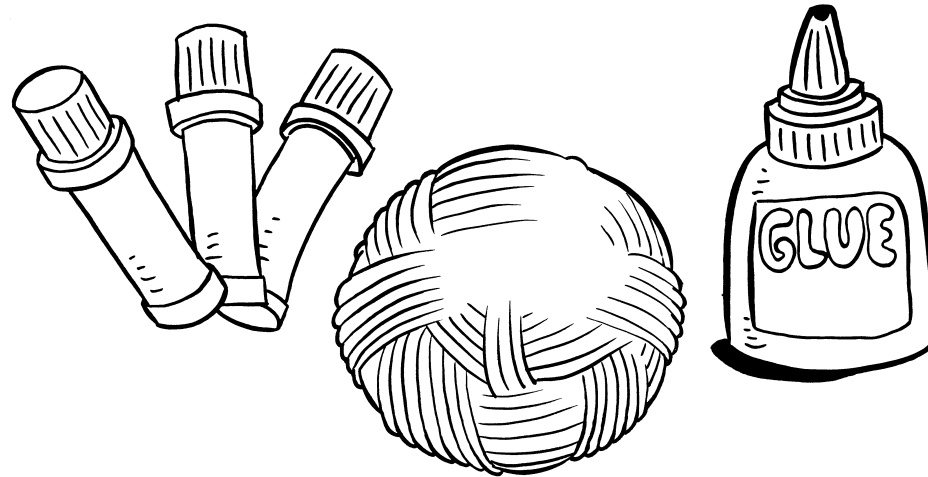

Instructions

Guide the play in each center reinforcing the unit theme.

Teacher Tips

- **IMPORTANT:** Do not allow any small toys in the classroom. First check all toys for size. You can obtain a "safety cylinder" from a pediatrician. Any object that can fit into the cylinder is too small and could cause a child to choke.
- Be involved in the group play and offer guidance as needed.
- Wear comfortable clothes suitable for sitting on the floor.
- Smile! Be childlike in heart and alert in mind.

Jesus Is Thankful

Ten Sick Men

The children will hear a story about one man being grateful that Jesus healed him.

Bible Story Text

Luke 17:11-19

Materials

For the teacher:

- Bible
- gloves from Unit 12 Lesson 1, Bible Story

Preparation

Familiarize yourself with the story and song.

A Thankful Man

Have the children sit in a small circle. *Has anyone ever been sick? How does it feel to be sick? Terrible! Let's pretend we're sick! OOH, my tummy hurts! Oh, my head hurts! It's not fun to be sick, is it?* Open the Bible to Luke. *Today we're going to learn a Bible story about ten men who were very sick. These men did not feel good. They wanted to get well! Can you think of anyone who could help them get well? Yes, Jesus! He could make them well! Jesus doesn't want anybody to be sick. He loves us and he always wants to help us.*

Put the gloves on and show the children the sick men. *How many sick men are here? Let's count together, one... two... three... four... five... six... seven... eight... nine... ten.... I have a special song for you that tells the Bible story about these ten sick men. Sing "Ten Sick Men" from the Unit 12 Song Sheet. Use the finger movements to tell the story.*

Let the children sing along as you repeat the song. Attach the heart to the index finger and say, *One came back to thank Jesus! He had a good heart! How many of the men came back to say thank you to Jesus? Yes, only one man came back. How did Jesus feel when everybody ran away and didn't say thank you? It made Jesus sad! He did something good for the men and they didn't even say thank you.*

How did Jesus feel when one man came back to say thank you? He felt very happy! If you were sick and Jesus made you well, what would you do? I'd give him a hug and a great big kiss! Let's all pretend to hug and kiss Jesus and tell him thank you! This makes Jesus very happy!

Conclusion

Ask the children, *Who healed the ten sick men? Yes, Jesus did!*

Pray with the children, to thank God for Jesus and for the Bible. *Thank you for the one sick man who was thankful when he got well. God, please help us to be thankful to our mommies and daddies and people that help us. Help us to be thankful to Jesus. Help us to always remember to say thank you! In Jesus' name we pray. Amen.*

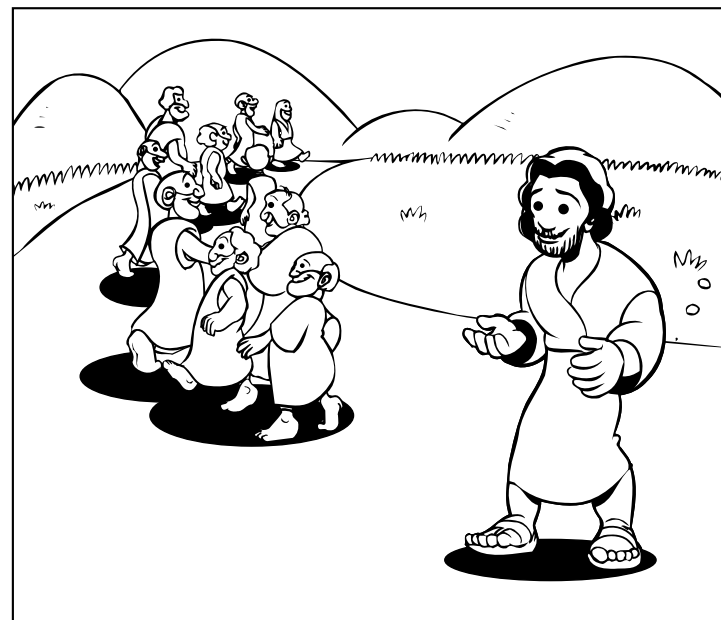

Jesus Is Thankful

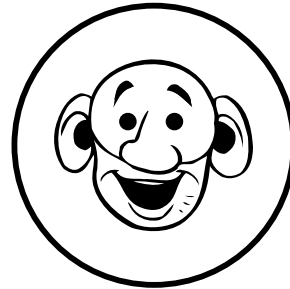
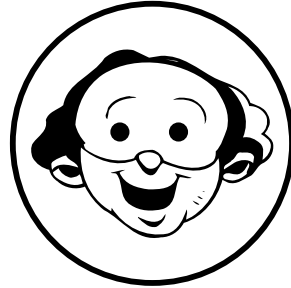
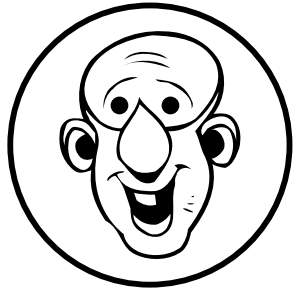
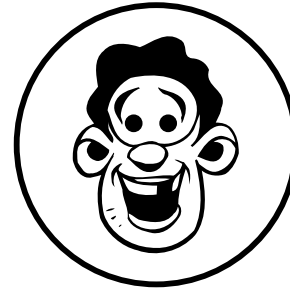
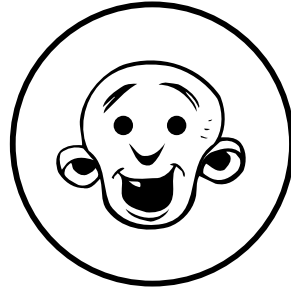
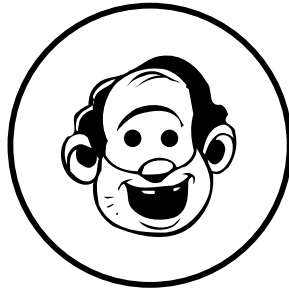
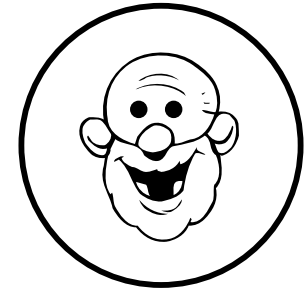
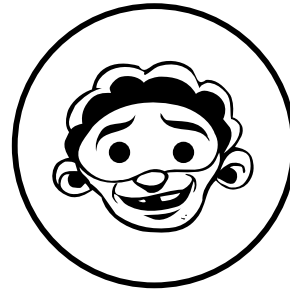
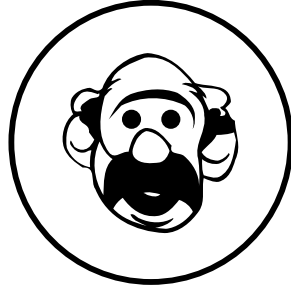

Jesus Is Thankful

Thank You

The children will learn to say thank you to parents and other grown-ups who take care of them when they are sick.

Bible Truth

Give thanks to God.
(Psalm 136:26)

Materials

For each child:

- 1 baby doll or stuffed animal
- 1 adhesive bandage (optional)
- 1 plastic spoon (optional)

For the teacher:

- teaching pictures from Unit 12 Lesson 1, Life Application

Preparation

Familiarize yourself with the activity and song.

Instructions

Do you remember a time when you got sick or got hurt?

Give each child time to respond. *Who took care of you when you were sick? What did they do to help you? Did they get you a pillow? Did they cover you with a blanket?*

Hold up the first picture. *Look at this boy. What do you think happened to him? He fell off his tricycle. Who is helping him? That's right. His daddy. What is his daddy doing? He is putting a bandage on his knee. The daddy is saying: "It will feel better soon." What does the little boy say? "Thank you, Daddy."* Give the picture to a child to hold.

Hold up the second picture. *Look at this girl. She is very sick. She has a temperature. Have you ever had a temperature? How did it make you feel? Who took care of you when you were sick? Who is helping this girl? Right, her mommy is helping her. What is her mommy doing? She is giving her medicine. Her Mommy is saying: "This will make you feel better." What does the little girl say? "Thank you, Mommy."* Let a child hold the picture.

Hold up the third picture. *What do you think is wrong with this boy? He got stung by a bee, and he is crying. It hurts to get stung by a bee. Who is helping him? His grandmother. What is she doing? She is hugging him and she is putting ice on his bee sting. Grandma is saying: "I am sorry, I know it hurts. It is okay to cry. It will feel better soon." What does the boy say? "Thank you, Grandma."* Let a child hold the picture.

Hold up the fourth picture. *Look at this girl. What happened to her? The swing bumped her head. Have you ever been hit by a swing? It hurts, doesn't it? Who is helping her? Her teacher. What is her teacher doing? He is hugging her, and he is looking at the bump on her head to see if it is swelling. Her teacher is saying: "I am sorry the swing bumped your head. Let's go get some ice to put on it. What does the girl say? "Thank you."* Let a child hold the picture.

Collect the pictures, and then give each child a baby doll. *Let's pretend our babies are sick. What do we need to do to help our babies? Let the children answer. We hug our babies. We kiss our babies. Hug and kiss the babies. We give our babies medicine. Pretend to give them medicine. We rock our babies and we put our babies to bed. Pretend to put them in a bed and cover them up. Goodnight babies. You will feel better soon. I love you. Now it is morning, and our babies are waking up. Our babies are all better now!*

Bible Truth Activity

God takes good care of us when we are sick. He gives us people to help us. If we say thank you and let them help us, it will help them to know that God loves them. God wants us to be thankful for him and for the people who take care of us.

Who remembers our Bible Truth? Give thanks to God. Repeat the Bible Truth a few times with the children.

Jesus Is Thankful

Conclusion

Say a short prayer. *Thank you, God, for my family and for grown-ups who love and take care of me.*

Teacher Tips

- Have the children pass the pictures so that each child gets a turn to hold a picture.
- The children can use spoons to give their baby dolls pretend medicine and adhesive bandages in addition to the other ways they role play taking care of their "babies."



Jesus Is Thankful

One Came Back

The children will make picture cards that will help them remember the story of the ten lepers.

Materials

For each child:

- 1 piece of construction paper
- crayons
- glue stick

For the teacher:

- scissors
- black marker
- white glue

Reproducible Pages:

- Page A, 1 copy for each child
- Page B, 1 copy for each child

Preparation

1. Cut out the pictures from the copies of Reproducible Pages A and B.
2. Prepare a piece of construction paper for each child as follows:
 - A. Make a 4" vertical fold in the construction paper on the left side, as shown in Figure A.
 - B. Write "One Came Back" on the front of the folded left panel near the top. See Figure B.
3. Make a model of the craft following the instructions.

Instructions

1. Open the card and show the children the Jesus picture. *In today's Bible story, Jesus heals ten men who were sick. Look, here is Jesus! How many men are in this picture? Let's count together, one... two... three... four... five... six... seven... eight... nine... ten..... These ten men were very sick and Jesus made them well. Look! One man came back to say, "thank you." This made Jesus very happy. None of the other men came back to say, "thank you" to Jesus.*
2. Give each child a Jesus picture and a piece of folded construction paper. Help them to glue the picture to the inside of the cards on the right side. See Figure C. NOTE: Align the left edge of the picture with the fold of the construction paper.
3. Give each child a picture of the thankful man. Help them to glue the picture to the front of the folded left panel of the card. See Figure D. NOTE: Align the right edge of the picture with the edge of the construction paper.
4. Have the children color their pictures.

Conclusion

Let the children open and shut their cards. Count the number of men with the children aloud. Ask, *Who healed the ten sick men? That's right, Jesus!*

Teacher Tips

- If time allows, sing "Ten Sick Men" from the Unit 12 Song Sheet. Point to the picture of the sick men in the card as you sing.

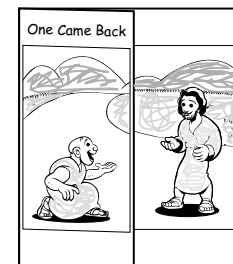

C
r
a
f
t



craft

Jesus Is Thankful

Thankfulness Lesson 2

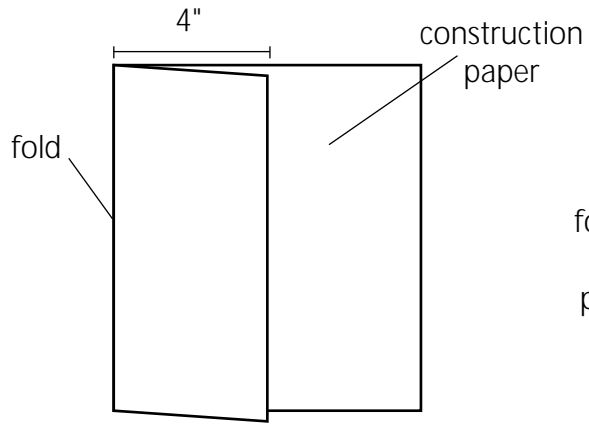

Figure A

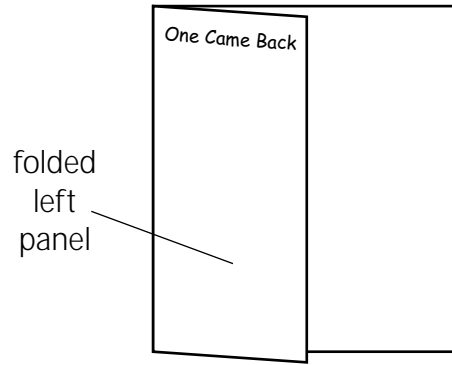

Figure B

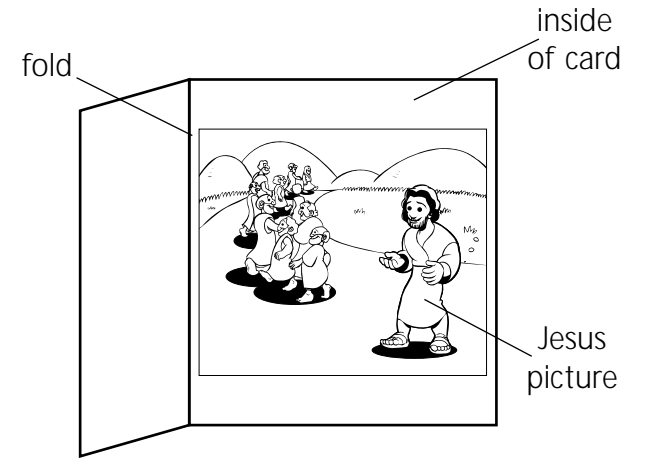

Figure C

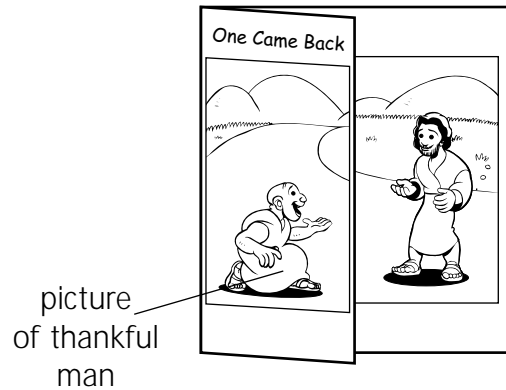
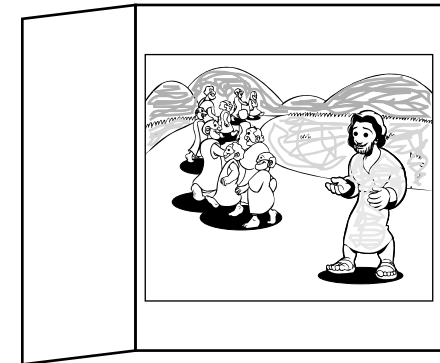

Figure D



front



inside

Finished Craft





Jesus Is Thankful

Thankfulness

Lesson 2

Lesson Objectives

- When asked who healed the ten sick men, the children will answer "Jesus."
- The children will thank an adult for taking care of them.
- The children will thank God for taking care of them.

Bible Story Text

Luke 17:11-19

Bible Truth

Give thanks to God.
(Psalm 136:26)

Preclass Centers

As the children arrive, guide them to a pre-class center. Have no more than six children at each center.

Materials

Use the materials previously selected for this unit's preclass centers.

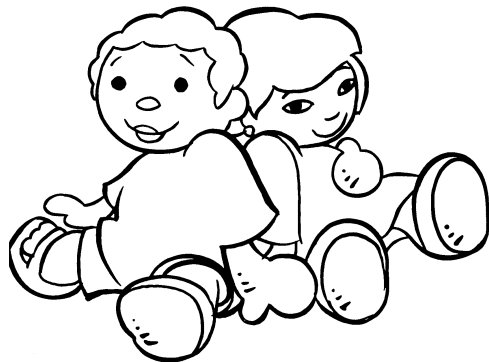

Lesson Plan

Greeting and Registration

Preclass Activity: Preclass Centers

Welcome and Singing

Centers:

Life Application: 'Thank You' Cards

Bible Story: Ten Sick Men

Craft: 'Thank You' Flowers

NOTE: Be sure to allow sufficient time for a snack.

Preparation

1. Be sure to check the condition of the materials selected for this unit's preclass centers prior to set up. Replace any broken toys, or puzzles with missing pieces as necessary.
2. Set up the centers before the children come into the classroom.
3. Assign a teacher to each center and have the teachers stay in those centers until the singing begins.

Instructions

Guide the play in each center reinforcing the unit theme.

Teacher Tips

- **IMPORTANT:** Do not allow any small toys in the classroom. First check all toys for size. You can obtain a "safety cylinder" from a pediatrician. Any object that can fit into the cylinder is too small and could cause a child to choke.
- Be involved in the group play and offer guidance as needed.
- Wear comfortable clothes suitable for sitting on the floor.
- Smile! Be childlike in heart and alert in mind.

'Thank You' Cards

The children will make "thank you" cards for a grown-up who takes care of them.

Bible Truth

Give thanks to God.
(Psalm 136:26)

Materials

For each child:

- 1 piece of construction paper
- crayons or markers
- glue stick

For the teacher:

- Bible
- stickers
- scissors
- magazines or advertisements (optional)
- pictures of the children (optional)
- pictures from Unit 12 Lesson 1, Life Application

Reproducible Pages:

- Page C, 1 copy for each child

Preparation

1. Cut out the card insert from the copies of Reproducible Page C.
2. Fold each piece of construction paper in half (like a card) for each child.
3. Make a model of the card following the instructions.

Instructions

1. Show the children the pictures from Unit 12 Lesson 1, Life Application. Talk about each picture and what the adult is doing to help the child.
2. Talk to the children about who helps them when they are sick or hurt.
3. Show the model card. *Here is a card that says "thank you" to a grown-up who takes care of you.*

Jesus Is Thankful

4. Give each child a piece of folded construction paper.
5. Have them decorate the outside of the card with markers and crayons.
6. Help each child glue the card insert inside their cards. See Figure A.
7. Ask each child who the card is for. Write the name of the grown-up in the space on the first line. Write the child's name next to the word "Love,"

Bible Truth Activity

God wants us to be thankful for him and for the people who take care of us. Who remembers our Bible Truth? Open the Bible. The Bible says, "Give thanks to God." Let's all say it together: "Give thanks to God."

Conclusion

Let's pray to thank God for grown-ups who love us and take care of us. Dear God, thank you for Daddy and Mommy and Grandma and our teachers. (Use some of the names the children have already mentioned in your prayer.) Thank you for giving us people to love us and take care of us.

Teacher Tips

- Give the children any optional items to decorate their cards as they color.
- Cut out happy pictures from the magazines for the children to use to decorate their cards.

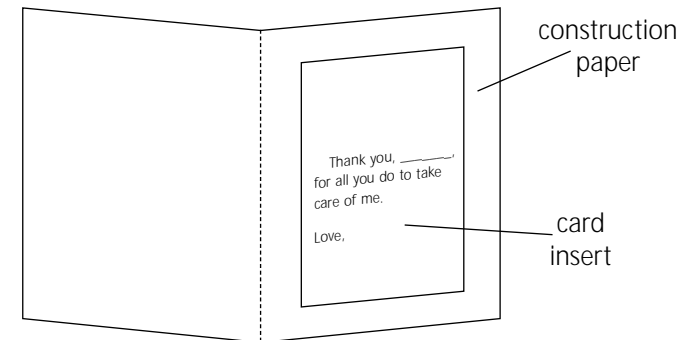

Figure A

Ten Sick Men

The children will hear a story about one man being grateful that Jesus healed him.

Bible Story Text

Luke 17:11-19

Materials

For the teacher:

- Bible
- gloves from Unit 12 Lesson 1, Bible Story

Preparation

Familiarize yourself with the story and song.

A Thankful Man

Have the children sit in a small circle. *Has anyone ever been sick? How does it feel to be sick? Terrible! Let's pretend we're sick! OOH, my tummy hurts! Oh, my head hurts! It's not fun to be sick, is it?* Open the Bible to Luke. *Today we're going to learn a Bible story about ten men who were very sick. These men did not feel good. They wanted to get well! Can you think of anyone who could help them get well? Yes, Jesus! He could make them well! Jesus doesn't want anybody to be sick. He loves us and he always wants to help us.*

Put the gloves on and show the children the sick men. *How many sick men are here? Let's count together, one... two... three... four... five... six... seven... eight... nine... ten.... I have a special song for you that tells the Bible story about these ten sick men. Sing "Ten Sick Men" from the Unit 12 Song Sheet. Use the finger movements to tell the story.*

Let the children sing along as you repeat the song. Attach the heart to the index finger and say, *One came back to thank Jesus! He had a good heart! How many of the men came back to say thank you to Jesus? Yes, only one man came back. How did Jesus feel when everybody ran away and didn't say thank you? It made Jesus sad! He did something good for the men and they didn't even say thank you.*

How did Jesus feel when one man came back to say thank you? He felt very happy! If you were sick and Jesus made you well, what would you do? I'd give him a hug and a great big kiss! Let's all pretend to hug and kiss Jesus and tell him thank you! This makes Jesus very happy!

Conclusion

Ask the children, *Who healed the ten sick men? Yes, Jesus did!*

Pray with the children, to thank God for Jesus and for the Bible. *Thank you for the one sick man who was thankful when he got well. God, please help us to be thankful to our mommies and daddies and people that help us. Help us to be thankful to Jesus. Help us to always remember to say thank you!*



B
i
b
l
e
S
t
o
r
y

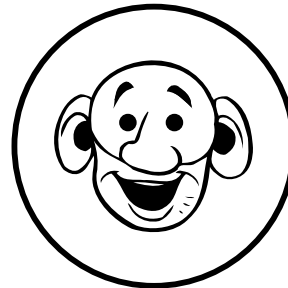
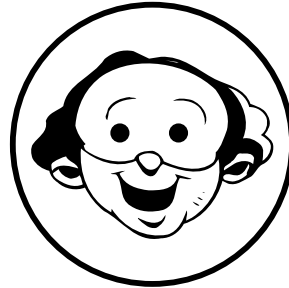
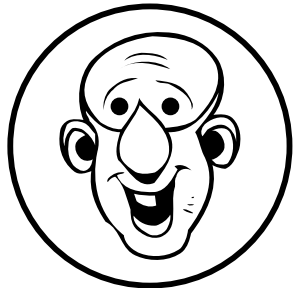
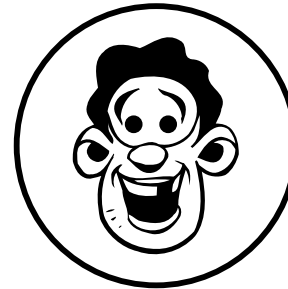
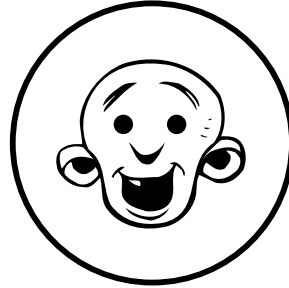
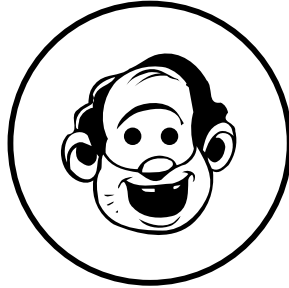
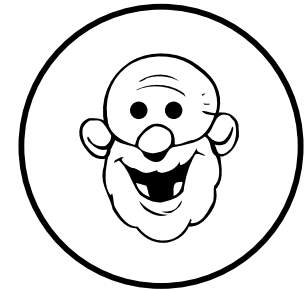
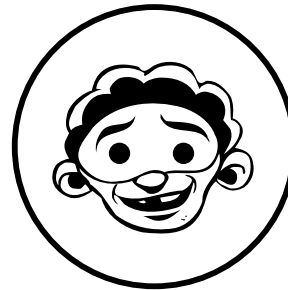
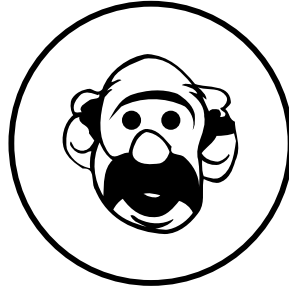

'Thank You' Flowers

The children will be able to give their parents bouquets of flowers as an expression of their gratitude.

Materials

For each child:

- toilet paper roll
- glue stick

For the teacher:

- scissors
- green construction paper
- colored construction paper
- markers
- glue stick
- tape

Reproducible Pages:

- Page D, 1 copy for each child

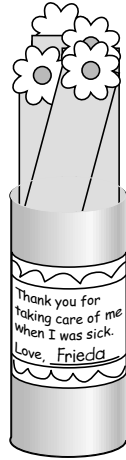

Preparation

1. Prepare four "flowers" for each child as follows:
 - A. Cut out the stencils from a copy of Reproducible Page D.
 - B. Trace and cut out four flowers from the colored construction paper.
 - C. Trace and cut out four flower centers from the colored construction paper.
2. Prepare a "flower base" for each child as follows:
 - A. Cut a 4½" x 6" piece of green construction paper.
 - B. Glue the green paper to the toilet paper roll.
3. Prepare "flower stems" for each child as follows:
 - A. Cut a 9" x 8" piece of green construction paper.
 - B. Measure every two inches and then cut three 3½" slits in the paper. See Figure A.
4. Make a model of the craft following the instructions.

Instructions

1. Show the children your model and say, *Aren't these flowers beautiful! I love it when people give me flowers, don't you? When you are sick does your mommy take care of you? Does your daddy take care of you? Let's say thank you by making them flowers!*
2. Give the children each four flowers and flower centers. Have the children glue their flower centers to their flowers. See Figure B.
3. Give the children each a flower stem. Have them glue their flowers to the ends of the flower stem. See Figure C.
4. Give each child a flower base and a text box.
5. Write their names on the text box.
6. Have the children glue their text boxes to their flower bases. See Figure D.
7. Help the children to roll their flower stems, and then place them into the flower bases. NOTE: Roll the paper so that the flowers are facing outward.

Conclusion

Have the children take turns presenting the flowers to each other and saying, "Thank you for taking care of me."

Teacher Tips

Bring a bottle of spray perfume to spray on the flowers when they are completed.

C
r
a
f
t

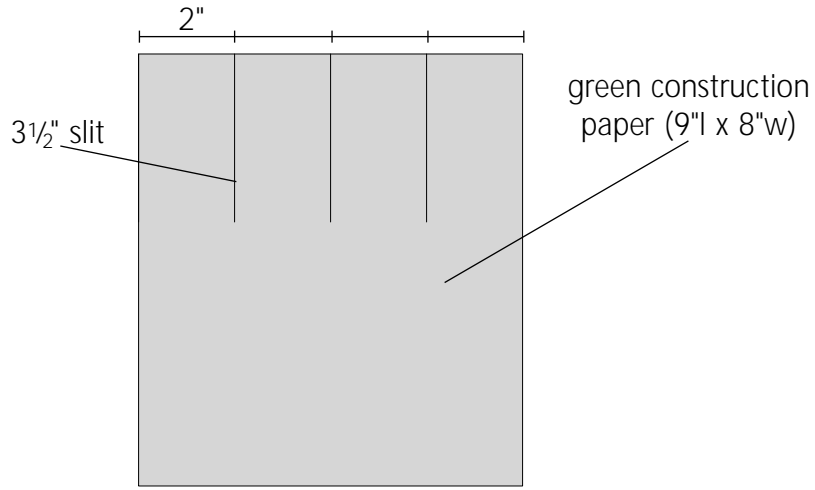

Figure A

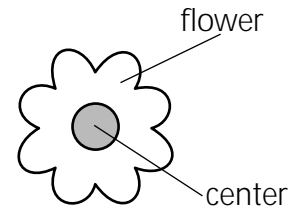

Figure B

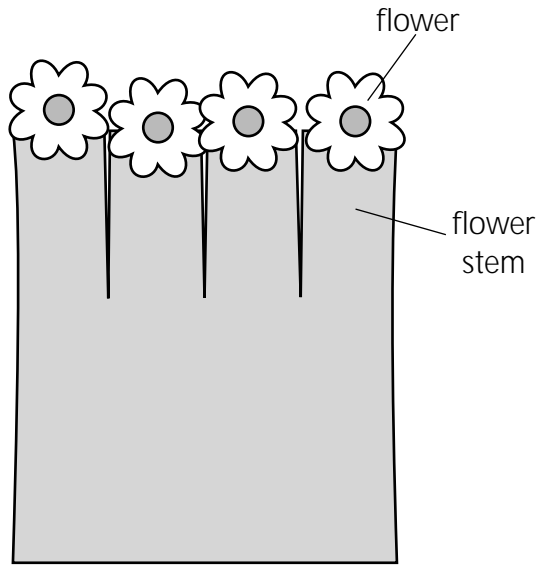

Figure C

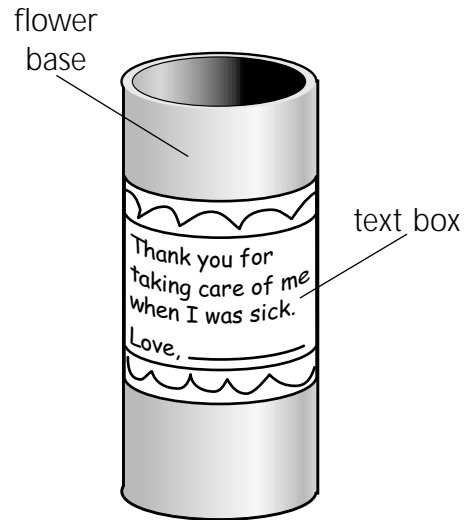
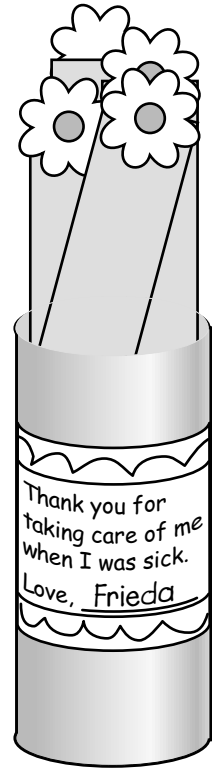

Figure D



Finished Craft





R
e
p
r
o
d
u
c
e
-
b
-
e



thankful man





R
e
p
r
o
d
u
c
e
d
b
y



Jesus picture





DEB-CUQO-rpER

Thank you, _____,
 for all you do to take
 care of me.

Love,

card insert





R
e
p
r
o
d
u
c
i
o
n
s

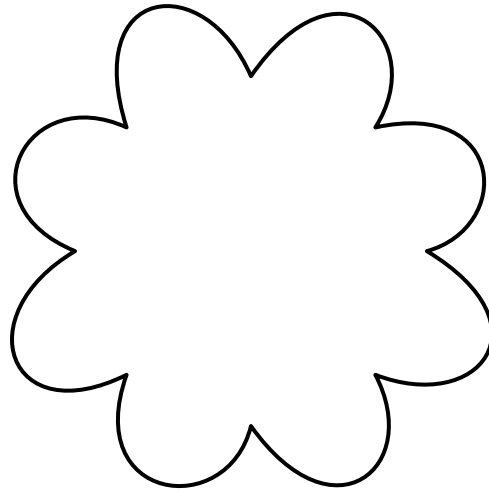

flower stencil

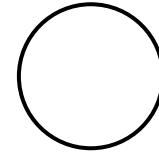

flower center



text box

